

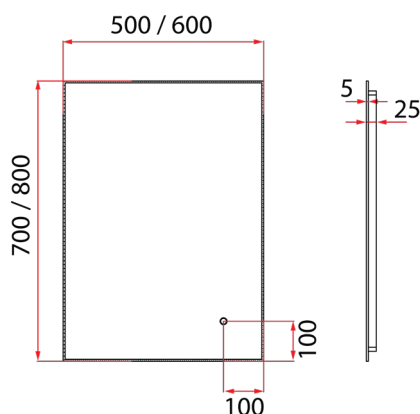











Rubine's ACO LED Mirror offers three light color options: warm, neutral, and white. Its 5mm thickness means it's durable and sturdy. These mirrors are lightweight, non-metallic, and corrosion-resistant, perfect for bathrooms. You can easily control the lighting with a simple touch, no buttons needed. Adjust the brightness smoothly to suit your preference, from soft ambient light to bright illumination.

No more foggy mirrors! The built-in demister keeps it clear, even in steamy conditions, ideal for makeup and shaving. It's splash-proof, protecting against water and dust. Plus, with a two-year warranty, you're covered against any manufacturing defects, giving you peace of mind.



* Measured in Millimeters (mm)
 * Product dimension is for reference only.
 * Kindly allow 1-3cm of difference in actual product.

-  Touch Sense Switch
-  IP44 Rated
-  Stepless Dimming
-  Quick & Easy Installation
-  Tricolor LED
-  5mm Non-metallic Mirror
-  Demister
-  CE Approved
-  Vertical / Horizontal

Product Information		
Model	RBM-ACO L57LED	RBM-ACO L68LED
Frame Material	Frameless	
Colour	Nil	
Installation	Horizontal / Vertical Wall-Mounted	
Overall Dimension	500 x 700 x 25mm	600 x 800 x 25mm
Weight	5.2kg	7.0kg
Package Included	Mirror + Mounting Hardware	
Warranty (T&C's Apply)	1 year on mirror desilvering	

*Copyright. All Rights Reserved. Rubine is constantly improving its products and make changes if deemed necessary.