



Superinox™
High-Grade
Stainless Steel



PVD Nano
Coating



Heat
Resistance



Anti-Condensation
Coating



High Scratch
Resistance



Anti-Stain



Anti-Bacterial



3mm Thick
Anti-Noise Pad

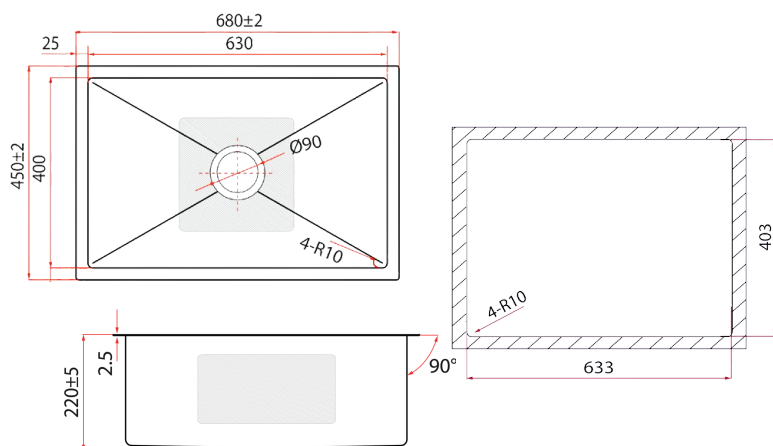
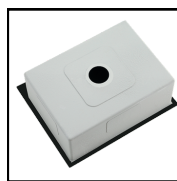

* All measurements are in millimeters (mm).

* Product dimensions are provided for reference only and may vary due to manufacturing tolerances.

* Countertop cut-out or installation should not be carried out based solely on this drawing.

* Fabrication and countertop cut-out must be based on measurements taken from the physical product.

Product Information

Model	KNX 810-68U-SS (Stone)
Material	18/8 Stainless Steel
Surface Finishing	PVD Nano Stone Surface
Installation	Undermount OR Inset
Pre-Punch Tap Hole	No
Sound Deadening Pads	Yes
Anti-Condensing	Yes
Thickness	1.2 mm
Reversible	Yes
Overflow	No
Overall Dimension	680 x 450 x 220 mm
Bowl Dimension	630 x 400 mm
Package Included	3½" Basket Waste and Bottle Trap + Cut-Out Template + Clips
Warranty (T&C's Apply)	5 Years Against Rust on Sink Surface (with Proper Maintenance)

Copyright ©. All Rights Reserved. Rubine is constantly improving its products and reserves the right to make changes if deemed necessary.